



Schornsteinsysteme aus Edelstahl



PREISLISTE 2023

# UNTERDRUCK DOPPELWANDIG



Doppelwandige Schornstein-  
und Abgassysteme aus Edelstahl

- System III FU
- System III G

Auflage 1.1 - gültig ab Dezember 2023





## Downloads

Auf unserer Homepage [www.poll-schornsteine.de](http://www.poll-schornsteine.de) steht Ihnen ein umfangreicher Downloadbereich zur Verfügung:

- ✓ Zulassungen
- ✓ Planungshilfen
- ✓ Montageanleitungen
- ✓ Bestelllisten

im pdf-Format für jedes System.





SYSTEMBESCHREIBUNG

# System III FU

Das System III FU ist ein doppelwandiges wärmedämmtes Edelstahlabgassystem für alle Regelfeuerstätten im Unterdruckbetrieb in trockener und feuchter (kondensierender) Betriebsweise. Anwendung findet das System bei Wärmeerzeugern mit Abgastemperaturen von bis zu 600 °C und ist somit für Festbrennstoffe, Heizöl EL und Gas geeignet.

Zwischen Innen- und Außenschale sorgt eine Wärmedämmschicht aus 35mm Mineralwolle für die nötige Wärmedämmung. Somit ist das System in die Wärmedurchlasswiderstandsgruppe II a eingeordnet. Auch bei starken Temperaturschwankungen zeigt sich das System III FU unempfindlich gegen Dehnung und Kontraktion.

**Oberflächen Außenmantel**

matt 2B	Standard	3U05-
glänzend 2R	ohne Aufpreis	3E05-
gebürstet	20% Aufpreis	Auf Anfrage
seewasserbeständig*	15% Aufpreis	Auf Anfrage
RAL-Lackierung**	40% Aufpreis	Auf Anfrage
Kupfer	50% Aufpreis	Auf Anfrage

Material Innenrohr		
1.4539	85% Aufschlag	Auf Anfrage

\* Außenmantel Werkstoff 1.4404

\*\* Mindest-Bestellwert 100,- € netto



Gefertigt wird das System im Durchmesserbereich von 80 mm bis 600 mm und erreicht durch den dünnwandigen Innenmantel schnell die Temperatur der Abgase und sorgt dadurch für eine geringe Kondensatbildung und hohe Zugbeständigkeit.

Brennstoff	Festbrennstoffe	✓
	Pellets	✓
	Gas	✓
	Heizöl EL	✓
Werkstoff innen & Betriebsweise		<b>1.4404</b> rußbrandbeständig oder feuchteunempfindlich
		<b>1.4539</b> (auf Anfrage) rußbrandbeständig und feuchteunempfindlich
Werkstoff außen		<b>1.4301</b> matt (weitere Oberflächen auf Anfrage)
Druckklasse	N1	✓ -40 Pa
	P1	⊖
	H1	⊖
Max. Abgastemperatur	600°C	
Wärmedämmung	35 mm	
Wandstärke	0,5 mm	
Verbindung	Steckverbindung Muffe/Sicke mit Spannring	
Spannring	nicht im Lieferumfang enthalten - separat bestellen	
Für waagerechten Einbau (VB-Leitung) geeignet	✓ (siehe auch Heft VB-Leitung)	





Di [mm]	Ø 80	Ø 100	Ø 113	Ø 130	Ø 150	Ø 180	Ø 200	Ø 250	Ø 300	Ø 350	Ø 400	Ø 450	Ø 500	Ø 600
Da [mm]	Ø 150	Ø 170	Ø 183	Ø 200	Ø 220	Ø 250	Ø 270	Ø 320	Ø 370	Ø 420	Ø 470	Ø 520	Ø 570	Ø 670
<b>3U05PD4## - Standard Paket - trocken 4,0m</b>														<b>RG: 3U</b>
##-Kürzel				13	15	18								
€/Stk.				<b>1572,-</b>	<b>1698,-</b>	<b>1893,-</b>								
Höhe [mm]				4000	4000	4000								
Gewicht [kg]				39	47	52								



### 3U05PD4##

Standard Paket - trocken 4,0m

trockene Betriebsweise

Holz & Pellets - trocken

#### Paketinhalt:

1 Stk.	99K00	Profil-Konsole 750mm, kürzbar
1 Stk.	3U05VGC##	Fundamentverankerung mit Ablauf für Profil-Konsole
1 Stk.	3005P30##	Prüf- & Reinigungs-Element mit geb. Tür (trocken)
1 Stk.	3U05F90##	F-Anschluss 90°
1 Stk.	3005UFK##	Übergangsstück kürzbar flach mit Wandfutter L: 500mm
1 Stk.	3U05R01##	Mauerblende
3 Stk.	3U05100##	Längenelement 1000 mm
1 Stk.	3U05MFL##	Mündungsabschluss flach
7 Stk.	3U05SS1##	Spannring
1 Stk.	3U05W20##	Wandbefestigung Wandabstand 50mm



Di [mm]	Ø 80	Ø 100	Ø 113	Ø 130	Ø 150	Ø 180	Ø 200	Ø 250	Ø 300	Ø 350	Ø 400	Ø 450	Ø 500	Ø 600
Da [mm]	Ø 150	Ø 170	Ø 183	Ø 200	Ø 220	Ø 250	Ø 270	Ø 320	Ø 370	Ø 420	Ø 470	Ø 520	Ø 570	Ø 670

**3U05PD0## - Formteilset - trocken** RG: 3U

##-Kürzel				13	15	18								
€/Stk.				795,-	848,-	964,-								
Gewicht [kg]				15,5	17,6	21,4								

**3U05PD0##**

Formteilset - trocken  
trockene Betriebsweise

**Paketinhalt:**

1 Stk.	3U05VGC##	Fundamentverankerung mit Ablauf für Profil-Konsole
1 Stk.	3005P30##	Prüf- & Reinigungs-Element mit geb. Tür (trocken)
1 Stk.	3U05F90##	F-Anschluss 90°
1 Stk.	3005UFK##	Übergangsstück kürzbar flach mit Wandfutter L: 500mm
1 Stk.	3U05R01##	Mauerblende
1 Stk.	3U05MFL##	Mündungsabschluss flach
4 Stk.	3U05SS1##	Spannring

Längen- und Befestigungselemente sind entsprechend zu ergänzen

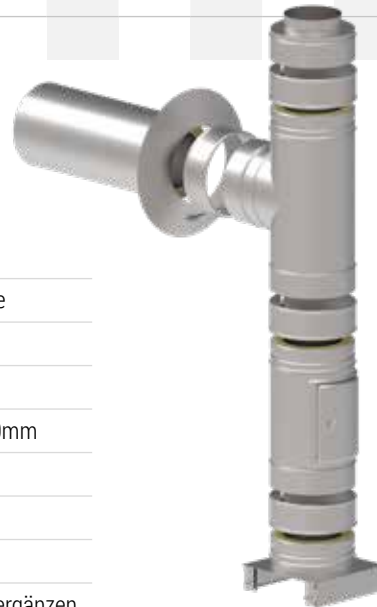

**3U05PW0## - Formteilset - feucht** RG: 3U

##-Kürzel				13	15	18								
€/Stk.				836,-	891,-	1007,-								
Gewicht [kg]				15,5	17,6	21,4								

**3U05PW0##**

Formteilset - feucht  
feuchte Betriebsweise

**Paketinhalt:**

1 Stk.	3U05VG3##	Fundamentverankerung mit Ablauf 50mm für Profil-Konsole
1 Stk.	3U05P30##	Prüf- & Reinigungs-Element mit geb. Tür (feucht)
1 Stk.	3U05F87##	F-Anschluss 87°
1 Stk.	3U05UFV##	Übergangsstück kürzbar mit einw. Stutzen L: 500mm
1 Stk.	3U05R01##	Mauerblende
1 Stk.	3U05MFL##	Mündungsabschluss flach
4 Stk.	3U05SS1##	Spannring

Längen- und Befestigungselemente sind entsprechend zu ergänzen





Di [mm]	Ø 80	Ø 100	Ø 113	Ø 130	Ø 150	Ø 180	Ø 200	Ø 250	Ø 300	Ø 350	Ø 400	Ø 450	Ø 500	Ø 600
Da [mm]	Ø 150	Ø 170	Ø 183	Ø 200	Ø 220	Ø 250	Ø 270	Ø 320	Ø 370	Ø 420	Ø 470	Ø 520	Ø 570	Ø 670

**3U05K00## - Konsolenbleche Wandabstand 50mm** **RG: 3U**

##-Kürzel	08	10	11	13	15	18	20	25	30	35	40	45	50	60
€/Stk.	<b>62,1</b>	<b>62,1</b>	<b>62,1</b>	<b>64,-</b>	<b>68,2</b>	<b>75,1</b>	<b>80,7</b>	<b>151,-</b>	<b>165,-</b>	<b>193,-</b>	<b>244,-</b>	<b>277,-</b>	<b>355,-</b>	<b>459,-</b>
A [mm]	255	275	285	305	325	355	375	425	475	525	575	625	675	755
C [mm]	137	147	162	175	190	212	227	265	302	340	377	415	452	527



Einbau: kurze Seite oben oder unten möglich | fester Wandabstand 50mm

**3U05KV0## - Grundbausatz Konsolenblech** **RG: 3U**

##-Kürzel	08	10	11	13	15	18	20	25	30	35	40	45	50	60
€/Stk.	<b>65,9</b>	<b>65,9</b>	<b>65,9</b>	<b>68,2</b>	<b>73,9</b>	<b>84,8</b>	<b>89,8</b>	<b>165,-</b>	<b>172,-</b>	<b>177,-</b>	<b>184,-</b>	<b>262,-</b>	<b>285,-</b>	<b>327,-</b>



nur in Kombination mit Abstandhalter verwendbar | Anschlussmaße siehe Abstandhalter

**3U05K11## - Abstandhalter für Grundbausatz 50-170mm** **RG: 3U**

##-Kürzel	08	10	11	13	15	18	20	25	30	35	40	45	50	60
€/Stk.	<b>99,9</b>	<b>99,9</b>	<b>99,9</b>	<b>104,-</b>	<b>105,-</b>	<b>115,-</b>	<b>115,-</b>	<b>136,-</b>	<b>150,-</b>	<b>159,-</b>	<b>191,-</b>	<b>259,-</b>	<b>270,-</b>	<b>300,-</b>
A [mm]	255	275	285	305	325	355	375	425	475	525	575	625	675	755
C [mm]	137	147	162	175	190	212	227	265	302	340	377	415	452	527

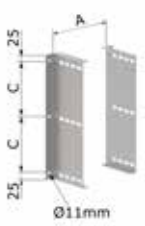

nur in Kombination mit Grundbausatz Konsolenblech verwendbar

**3U05K12## - Abstandhalter für Grundbausatz 170-290mm** **RG: 3U**

##-Kürzel	08	10	11	13	15	18	20	25	30	35	40	45	50	60
€/Stk.	<b>136,-</b>	<b>136,-</b>	<b>136,-</b>	<b>151,-</b>	<b>151,-</b>	<b>160,-</b>	<b>169,-</b>	<b>215,-</b>	<b>215,-</b>	<b>224,-</b>	<b>244,-</b>	<b>262,-</b>	<b>327,-</b>	<b>368,-</b>
A [mm]	255	275	285	305	325	355	375	425	475	525	575	625	675	755
C [mm]	137	147	162	175	190	212	227	265	302	340	377	415	452	527

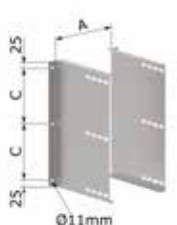

nur in Kombination mit Grundbausatz Konsolenblech verwendbar

**3U05K13## - Abstandhalter für Grundbausatz 290-410mm** **RG: 3U**

##-Kürzel	08	10	11	13	15	18	20	25	30	35	40	45	50	60
€/Stk.	<b>195,-</b>	<b>195,-</b>	<b>195,-</b>	<b>195,-</b>	<b>196,-</b>	<b>214,-</b>	<b>222,-</b>	<b>243,-</b>	<b>280,-</b>	<b>294,-</b>	<b>314,-</b>	<b>369,-</b>	<b>390,-</b>	<b>437,-</b>
A [mm]	255	275	285	305	325	355	375	425	475	525	575	625	675	755
C [mm]	137	147	162	175	190	212	227	265	302	340	377	415	452	527

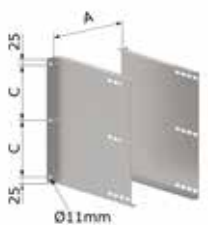

nur in Kombination mit Grundbausatz Konsolenblech verwendbar



Di [mm]	Ø 80	Ø 100	Ø 113	Ø 130	Ø 150	Ø 180	Ø 200	Ø 250	Ø 300	Ø 350	Ø 400	Ø 450	Ø 500	Ø 600
Da [mm]	Ø 150	Ø 170	Ø 183	Ø 200	Ø 220	Ø 250	Ø 270	Ø 320	Ø 370	Ø 420	Ø 470	Ø 520	Ø 570	Ø 670

**99K02 - Profil-Konsole 500mm, kürzbar** **RG: 3U**

€/Stk. **144,-**



Langlöcher 21x11mm

für die Durchmesser Di 80 mm - 250 mm geeignet

**99K00 - Profil-Konsole 750mm, kürzbar** **RG: 3U**

€/Stk. **173,-**



Langlöcher 21x11mm

für die Durchmesser Di 80 mm - 250 mm geeignet

**3U05H00## - Hocker** **RG: 3U**

##-Kürzel	08	10	11	13	15	18	20	25	30	35	40	45	50	60
€/Stk.	<b>65,2</b>	<b>65,2</b>	<b>65,2</b>	<b>65,2</b>	<b>65,2</b>	<b>74,2</b>	<b>82,2</b>	<b>116,-</b>	<b>141,-</b>	<b>177,-</b>	<b>188,-</b>	<b>196,-</b>	<b>205,-</b>	<b>250,-</b>
A [mm]	190	210	220	240	260	290	310	360	410	460	510	560	610	710
B [mm]	215	235	245	265	285	315	335	385	435	485	535	585	635	735

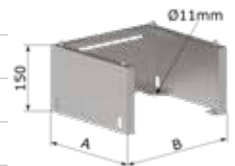

**3U05H11## - Verlängerung für Hocker 150-270mm** **RG: 3U**

##-Kürzel	08	10	11	13	15	18	20	25	30	35	40	45	50	60
€/Stk.	<b>76,5</b>	<b>76,5</b>	<b>76,5</b>	<b>76,5</b>	<b>76,5</b>	<b>91,-</b>	<b>93,1</b>	<b>110,-</b>	<b>157,-</b>	<b>176,-</b>	<b>180,-</b>	<b>191,-</b>	<b>199,-</b>	<b>209,-</b>



auch für die Stütze für Bögen 3U05KST## verwendbar

**3U05H12## - Verlängerung für Hocker 270-390mm** **RG: 3U**

##-Kürzel	08	10	11	13	15	18	20	25	30	35	40	45	50	60
€/Stk.	<b>102,-</b>	<b>102,-</b>	<b>102,-</b>	<b>102,-</b>	<b>102,-</b>	<b>118,-</b>	<b>136,-</b>	<b>146,-</b>	<b>217,-</b>	<b>221,-</b>	<b>230,-</b>	<b>244,-</b>	<b>256,-</b>	<b>270,-</b>



auch für die Stütze für Bögen 3U05KST## verwendbar

**3U05H13## - Verlängerung für Hocker 390-510mm** **RG: 3U**

##-Kürzel	08	10	11	13	15	18	20	25	30	35	40	45	50	60
€/Stk.	<b>141,-</b>	<b>141,-</b>	<b>141,-</b>	<b>145,-</b>	<b>146,-</b>	<b>149,-</b>	<b>169,-</b>	<b>203,-</b>	<b>278,-</b>	<b>296,-</b>	<b>312,-</b>	<b>336,-</b>	<b>359,-</b>	<b>383,-</b>



auch für die Stütze für Bögen 3U05KST## verwendbar



# SYSTEM III FU

Di [mm]	Ø 80	Ø 100	Ø 113	Ø 130	Ø 150	Ø 180	Ø 200	Ø 250	Ø 300	Ø 350	Ø 400	Ø 450	Ø 500	Ø 600
Da [mm]	Ø 150	Ø 170	Ø 183	Ø 200	Ø 220	Ø 250	Ø 270	Ø 320	Ø 370	Ø 420	Ø 470	Ø 520	Ø 570	Ø 670

### 3U05SFA## - Stützfuß mit seitr. Ablauf RG: 3U

##-Kürzel	08	10	11	13	15	18	20	25	30	35	40	45		
€/Stk.	173,-	173,-	173,-	211,-	233,-	258,-	285,-	351,-	493,-	564,-	571,-	634,-		

in der Höhe kürzbar

### 3U05SF1## - Stützfuß mit Reinigungstür und Flansch innen RG: 3U

##-Kürzel	08	10	11	13	15	18	20	25	30	35	40	45		
€/Stk.	239,-	239,-	239,-	267,-	294,-	323,-	420,-	519,-	624,-	728,-	831,-	935,-		

in der Höhe kürzbar

### 3U05SF2## - Stützfuß mit seitr. Ablauf DN 50mm RG: 3U

##-Kürzel				13	15	18	20							
€/Stk.				217,-	241,-	269,-	300,-							

in der Höhe kürzbar

### 3U05KST## - Stütze für Bogen 87° RG: 3U

##-Kürzel	08	10	11	13	15	18	20	25	30	35	40	45	50	60
€/Stk.	149,-	151,-	155,-	169,-	195,-	212,-	228,-	252,-	289,-	309,-	333,-	351,-	368,-	408,-
A [mm]	190	210	220	240	260	290	310	360	410	460	510	560	610	710
B [mm]	215	235	245	265	285	315	335	385	435	485	535	585	635	735
E [mm]	408	428	440	457	476	506	525	574	623	672	719	768	817	914

nur in Kombination mit einer Verlängerung für Hocker verwendbar

### 3005V0K## - Fundamentverankerung mit Kondensattopf für Konsolenbleche RG: 3U

##-Kürzel	08	10	11	13	15	18	20	25	30	35	40	45	50	60
€/Stk.	115,-	115,-	115,-	115,-	127,-	155,-	171,-	217,-	247,-	351,-	380,-	441,-	485,-	574,-
A [mm]	190	210	220	240	260	290	310	360	410	460	510	560	610	710
B [mm]	210	230	240	260	280	310	330	380	430	480	530	580	630	730

### 3005V0C## - Fundamentverankerung mit Kondensattopf für Profil-Konsole RG: 3U

##-Kürzel	08	10	11	13	15	18	20	25						
€/Stk.	125,-	125,-	125,-	125,-	136,-	163,-	178,-	225,-						
A [mm]	190	210	220	240	260	290	310	360						
B [mm]	210	230	240	260	280	310	330	380						

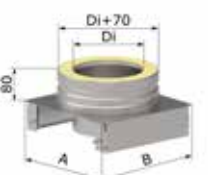
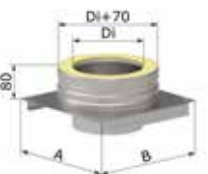





Di [mm]	Ø 80	Ø 100	Ø 113	Ø 130	Ø 150	Ø 180	Ø 200	Ø 250	Ø 300	Ø 350	Ø 400	Ø 450	Ø 500	Ø 600
Da [mm]	Ø 150	Ø 170	Ø 183	Ø 200	Ø 220	Ø 250	Ø 270	Ø 320	Ø 370	Ø 420	Ø 470	Ø 520	Ø 570	Ø 670
<b>3U05VGA## - Fundamentverankerung mit Ablauf 3/4" für Konsolenbleche</b>														<b>RG: 3U</b>
##-Kürzel	08	10	11	13	15	18	20	25	30	35	40	45	50	60
€/Stk.	<b>91,2</b>	<b>91,2</b>	<b>91,2</b>	<b>99,-</b>	<b>106,-</b>	<b>116,-</b>	<b>127,-</b>	<b>155,-</b>	<b>203,-</b>	<b>214,-</b>	<b>243,-</b>	<b>324,-</b>	<b>387,-</b>	<b>473,-</b>
A [mm]	190	210	220	240	260	290	310	360	410	460	510	560	610	710
B [mm]	210	230	240	260	280	310	330	380	430	480	530	580	630	730
<b>3U05VGC## - Fundamentverankerung mit Ablauf 3/4" für Profil-Konsole</b>														<b>RG: 3U</b>
##-Kürzel	08	10	11	13	15	18	20	25						
€/Stk.	<b>103,-</b>	<b>99,1</b>	<b>99,1</b>	<b>103,-</b>	<b>114,-</b>	<b>125,-</b>	<b>143,-</b>	<b>163,-</b>						
A [mm]	190	210	220	240	260	290	310	360						
B [mm]	210	230	240	260	280	310	330	380						
<b>3U05VG2## - Fundamentverankerung mit Ablauf 50mm für Konsolenbleche</b>														<b>RG: 3U</b>
##-Kürzel	08	10	11	13	15	18	20	25						
€/Stk.	<b>123,-</b>	<b>123,-</b>	<b>123,-</b>	<b>124,-</b>	<b>129,-</b>	<b>139,-</b>	<b>150,-</b>	<b>173,-</b>						
A [mm]	190	210	220	240	260	290	310	360						
B [mm]	210	230	240	260	280	310	330	380						
<b>3U05VG3## - Fundamentverankerung mit Ablauf 50mm für Profil-Konsole</b>														<b>RG: 3U</b>
##-Kürzel	08	10	11	13	15	18	20	25						
€/Stk.	<b>125,-</b>	<b>125,-</b>	<b>125,-</b>	<b>125,-</b>	<b>133,-</b>	<b>141,-</b>	<b>149,-</b>	<b>174,-</b>						
A [mm]	190	210	220	240	260	290	310	360						
B [mm]	210	230	240	260	280	310	330	380						
<b>3U05Z00## - Zwischenstütze für Konsolenbleche</b>														<b>RG: 3U</b>
##-Kürzel	08	10	11	13	15	18	20	25	30	35	40	45	50	60
€/Stk.	<b>96,9</b>	<b>96,9</b>	<b>96,9</b>	<b>106,-</b>	<b>116,-</b>	<b>136,-</b>	<b>150,-</b>	<b>181,-</b>	<b>205,-</b>	<b>222,-</b>	<b>256,-</b>	<b>314,-</b>	<b>353,-</b>	<b>551,-</b>
A [mm]	190	210	220	240	260	290	310	360	410	460	510	560	610	710
B [mm]	210	230	240	260	280	310	330	380	430	480	530	580	630	730
<b>3U05Z0C## - Zwischenstütze für Profil-Konsole</b>														<b>RG: 3U</b>
##-Kürzel	08	10	11	13	15	18	20	25						
€/Stk.	<b>105,-</b>	<b>107,-</b>	<b>108,-</b>	<b>118,-</b>	<b>131,-</b>	<b>154,-</b>	<b>169,-</b>	<b>211,-</b>						
A [mm]	190	210	220	240	260	290	310	360						
B [mm]	210	230	240	260	280	310	330	380						

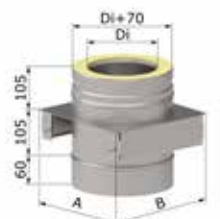
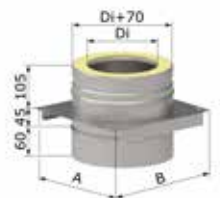
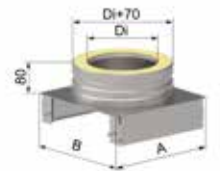
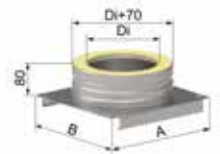
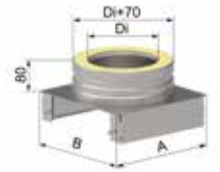
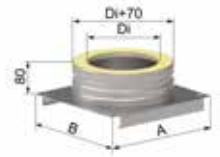



Di [mm]	Ø 80	Ø 100	Ø 113	Ø 130	Ø 150	Ø 180	Ø 200	Ø 250	Ø 300	Ø 350	Ø 400	Ø 450	Ø 500	Ø 600
Da [mm]	Ø 150	Ø 170	Ø 183	Ø 200	Ø 220	Ø 250	Ø 270	Ø 320	Ø 370	Ø 420	Ø 470	Ø 520	Ø 570	Ø 670

**3U05Z20## - Zwischenstütze 2tlg. für Profil-Konsole** RG: 3U

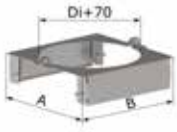

##-Kürzel	08	10	11	13	15	18	20	25						
€/Stk.	<b>57,3</b>	<b>57,3</b>	<b>57,3</b>	<b>57,3</b>	<b>57,3</b>	<b>67,3</b>	<b>70,4</b>	<b>91,2</b>						
A [mm]	190	210	220	240	260	290	310	360						
B [mm]	210	230	240	260	280	310	330	380						

Kann mit einer Profil-Konsole als Wandbefestigung eingesetzt werden

**3U056A1## - Kondensatschale mit Ablauf 3/4" unten als Deckel inkl. Spannung** RG: 3U



##-Kürzel	08	10	11	13	15	18	20	25	30	35	40	45		
€/Stk.	<b>83,6</b>	<b>83,6</b>	<b>86,7</b>	<b>86,7</b>	<b>92,5</b>	<b>102,-</b>	<b>107,-</b>	<b>128,-</b>	<b>136,-</b>	<b>150,-</b>	<b>178,-</b>	<b>221,-</b>		

**3U05VSA## - Fundamentverankerung mit seitr. Ablauf als bodenstehende Platte** RG: 3U



##-Kürzel	08	10	11	13	15	18	20	25	30	35	40	45	50	60
€/Stk.	<b>94,8</b>	<b>94,8</b>	<b>94,8</b>	<b>99,-</b>	<b>110,-</b>	<b>122,-</b>	<b>132,-</b>	<b>155,-</b>	<b>212,-</b>	<b>223,-</b>	<b>252,-</b>	<b>339,-</b>	<b>387,-</b>	<b>473,-</b>

**3005P30## - Prüf- & Reinigungs-Element mit geb. Tür (trocken)** RG: 3U



##-Kürzel				13	15	18	20							
€/Stk.				<b>301,-</b>	<b>301,-</b>	<b>324,-</b>	<b>341,-</b>							

**3U05P30## - Prüf- & Reinigungs-Element mit geb. Tür (feucht)** RG: 3U



##-Kürzel				13	15	18	20							
€/Stk.				<b>329,-</b>	<b>329,-</b>	<b>356,-</b>	<b>372,-</b>							

**3005P00## - Prüf- & Reinigungs-Element mit Kasten (trocken) 120x180mm** RG: 3U



##-Kürzel			11	13	15	18	20	25	30	35	40	45	50	60
€/Stk.			<b>301,-</b>	<b>301,-</b>	<b>301,-</b>	<b>324,-</b>	<b>341,-</b>	<b>383,-</b>	<b>413,-</b>	<b>459,-</b>	<b>492,-</b>	<b>566,-</b>	<b>707,-</b>	<b>707,-</b>



Di [mm]	Ø 80	Ø 100	Ø 113	Ø 130	Ø 150	Ø 180	Ø 200	Ø 250	Ø 300	Ø 350	Ø 400	Ø 450	Ø 500	Ø 600
Da [mm]	Ø 150	Ø 170	Ø 183	Ø 200	Ø 220	Ø 250	Ø 270	Ø 320	Ø 370	Ø 420	Ø 470	Ø 520	Ø 570	Ø 670

**3U05P00## - Prüf- & Reinigungs-Element mit Kasten (feucht) 120x180mm** RG: 3U

##-Kürzel	08	10	11	13	15	18	20	25	30	35	40	45	50	60
€/Stk.	329,-	329,-	329,-	329,-	329,-	356,-	372,-	413,-	445,-	467,-	515,-	706,-	707,-	707,-



**3U05PF0## - P + F 90° kombiniert gegenüberliegend** RG: 3U

##-Kürzel				13	15	18	20	25	30	35	40	45		
€/Stk.				485,-	499,-	569,-	618,-	796,-	957,-	1113,-	1271,-	1431,-		
A [mm]				195	196	197	197	323	325	326	327	329		
B [mm]				167	177	193	204	230	256	283	309	335		
C [mm]				245	244	243	243	367	365	364	363	361		



vor Einbau Rücksprache mit Bezirksschornsteinfeger halten

**3005NLV## - Nebenluftvorrichtung Z4** RG: 3U

##-Kürzel			11	13	15	18	20	25	30	35	40	45		
€/Stk.			284,-	284,-	302,-	391,-	435,-	482,-	532,-	596,-	667,-	868,-		



**3U05PHP## - Prüf- & Reinigungs-Element mit Universaldeckel** RG: 3U

##-Kürzel	08	10	11	13	15	18	20	25	30	35	40	45	50	60
€/Stk.	233,-	233,-	233,-	233,-	233,-	356,-	369,-	396,-	445,-	541,-	662,-	721,-	833,-	940,-
WL [mm]	340	340	340	340	340	340	340	440	440	440	440	440	440	440
d [mm]	100	100	100	130	150	150	150	200	200	200	250	250	250	250



**3U05F90## - F-Anschluss 90°** RG: 3U

##-Kürzel			11	13	15	18	20	25	30	35	40			
€/Stk.			177,-	189,-	203,-	243,-	280,-	417,-	480,-	576,-	729,-			
A [mm]			190	190	190	190	190	315	315	315	315			
B [mm]			153	161	172	187	197	222	247	272	297			
C [mm]			250	250	250	250	250	375	375	375	375			



**3U05F91## - F-Anschluss 90° reduziert** RG: 3U

##-Kürzel				15	18	20								
€/Stk.				319,-	357,-	412,-								
A [mm]				190	190	190								
B [mm]				172	187	197								
C [mm]				250	250	250								
Dx [mm]				130	150	180								





Di [mm]	Ø 80	Ø 100	Ø 113	Ø 130	Ø 150	Ø 180	Ø 200	Ø 250	Ø 300	Ø 350	Ø 400	Ø 450	Ø 500	Ø 600
Da [mm]	Ø 150	Ø 170	Ø 183	Ø 200	Ø 220	Ø 250	Ø 270	Ø 320	Ø 370	Ø 420	Ø 470	Ø 520	Ø 570	Ø 670

**3U05F45## - F-Anschluss 45°** RG: 3U

##-Kürzel	08	10	11	13	15	18	20	25	30	35	40	45	50	60
€/Stk.	267,-	267,-	267,-	279,-	296,-	410,-	435,-	587,-	678,-	728,-	969,-	1342,-	1782,-	2066,-
A [mm]	265	275	283	290	300	441	451	476	501	651	676	701	726	901
B [mm]	243	267	282	303	327	363	387	448	508	568	629	689	750	870
C [mm]	175	165	157	150	140	249	239	214	189	289	264	239	214	289

**3U05F87## - F-Anschluss 87°** RG: 3U

##-Kürzel	08	10	11	13	15	18	20	25	30	35	40	45	50	60
€/Stk.	178,-	178,-	178,-	188,-	205,-	250,-	268,-	436,-	481,-	576,-	700,-	930,-	1096,-	1626,-
A [mm]	187	186	185	185	184	183	183	307	305	304	303	301	300	422
B [mm]	141	151	158	167	177	193	204	230	256	283	309	335	362	415
C [mm]	253	254	255	255	256	257	257	383	385	386	387	389	390	518

**3U05FDK#### - F-Anschluss 90° mit Stutzen für Zugregler (ZUK 150)** RG: 3U

####-Kürzel				1315	1515	1815	2015							
€/Stk.				249,-	268,-	309,-	349,-							
A [mm]				190	190	190	190							
B [mm]				161	172	187	197							
C [mm]				250	250	250	250							

**9900ZUK150 - Präzisionszugbegrenzer mit Überdruckklappe (Ex-Klappe) D: 150mm** RG: 1U

€/Stk. 281,-

Luftgruppe 1-4 nach DIN 4795

**3U05100## - Längenelement 1000 mm** RG: 3U

##-Kürzel	08	10	11	13	15	18	20	25	30	35	40	45	50	60
€/Stk.	154,-	158,-	158,-	170,-	191,-	216,-	233,-	271,-	324,-	378,-	430,-	566,-	626,-	749,-

**3U05050## - Längenelement 500 mm** RG: 3U

##-Kürzel	08	10	11	13	15	18	20	25	30	35	40	45	50	60
€/Stk.	92,5	96,3	92,5	92,5	103,-	114,-	131,-	153,-	190,-	214,-	241,-	296,-	347,-	412,-



Di [mm]	Ø 80	Ø 100	Ø 113	Ø 130	Ø 150	Ø 180	Ø 200	Ø 250	Ø 300	Ø 350	Ø 400	Ø 450	Ø 500	Ø 600
Da [mm]	Ø 150	Ø 170	Ø 183	Ø 200	Ø 220	Ø 250	Ø 270	Ø 320	Ø 370	Ø 420	Ø 470	Ø 520	Ø 570	Ø 670

**3U05033## - Längenelement 330 mm** RG: 3U

##-Kürzel	08	10	11	13	15	18	20	25	30	35	40	45	50	60
€/Stk.	67,3	69,-	69,-	72,-	77,3	88,5	88,5	114,-	136,-	159,-	176,-	218,-	256,-	305,-



**3U05025## - Längenelement 250 mm** RG: 3U

##-Kürzel	08	10	11	13	15	18	20	25	30	35	40	45	50	60
€/Stk.	59,6	59,6	59,6	61,-	65,3	72,8	72,9	91,4	127,-	137,-	145,-	180,-	214,-	252,-

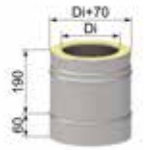

**3005UFF## - Übergangsstück mit Wandfutter** RG: 3U

##-Kürzel		10	11	13	15	18	20	25	30	35	40			
€/Stk.		70,-	70,-	78,4	89,8	117,-	126,-	146,-	160,-	172,-	176,-			



mit Rohrhülsenadapter kombinierbar

**3005UFE## - Übergangsstück kürzbar mit Wandfutter und einw. Stutzen L: 500mm** RG: 3U

##-Kürzel				13	15	18	20	25						
€/Stk.				118,-	133,-	168,-	176,-	206,-						



mit Rohrhülsenadapter kombinierbar

**3005UFK## - Übergangsstück kürzbar flach mit Wandfutter L: 500mm** RG: 3U

##-Kürzel		10	11	13	15	18	20	25						
€/Stk.		118,-	118,-	118,-	133,-	168,-	176,-	206,-						







# SYSTEM III FU

Di [mm]	Ø 80	Ø 100	Ø 113	Ø 130	Ø 150	Ø 180	Ø 200	Ø 250	Ø 300	Ø 350	Ø 400	Ø 450	Ø 500	Ø 600
Da [mm]	Ø 150	Ø 170	Ø 183	Ø 200	Ø 220	Ø 250	Ø 270	Ø 320	Ø 370	Ø 420	Ø 470	Ø 520	Ø 570	Ø 670

**1U05RHA##XX - Rohrhülsenadapter inkl. Wandfutter** RG: 1U

##-Kürzel			11	13	15	18	20							
€/Stk.			103,-	103,-	103,-	103,-	103,-							
XX-Kürzel	Dx reduziert - Kundenangabe													



**3005UFR### - Übergangsstück mit reduziertem Wandfutter** RG: 3U

###-Kürzel			1110	1312	1513	1813	2018	2520						
€/Stk.			134,-	99,7	99,7	134,-	146,-	181,-						
Dx [mm]			100	120	130	130	180	200						



**3U05UFV## - Übergangsstück für Feuerungsanschluss L: 500 mm, Innenrohr lose, kürzbar** RG: 3U

##-Kürzel	08	10	11	13	15	18	20	25						
€/Stk.	113,-	113,-	113,-	113,-	124,-	153,-	161,-	188,-						

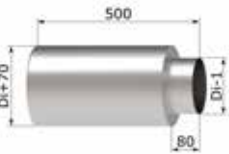

**3U05UEF## - Übergangsstück für Feuerungsanschluss** RG: 3U

##-Kürzel	08	10	11	13	15	18	20	25	30	35	40	45	50	60
€/Stk.	55,-	55,-	55,-	62,6	70,7	96,4	98,7	101,-	119,-	144,-	150,-	199,-	258,-	349,-



**3U05MFL## - Mündungsabschluss flach** RG: 3U

##-Kürzel	08	10	11	13	15	18	20	25	30	35	40	45		
€/Stk.	39,2	39,2	39,2	45,-	51,-	58,3	64,3	74,9	85,4	114,-	144,-	182,-		

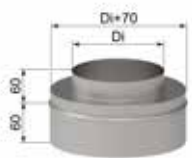

**1U05DGR## - Dohlengitter rund** RG: 1U

##-Kürzel	08	10	11	13	15	18	20	25	30	35	40	45	50	60
€/Stk.	36,7	36,7	36,7	37,2	45,9	52,-	58,4	64,9	80,7	235,-	265,-	372,-	552,-	630,-
E [mm]	105	125	138	155	175	169	185	225	265	305	345	385	425	505





Di [mm]	Ø 80	Ø 100	Ø 113	Ø 130	Ø 150	Ø 180	Ø 200	Ø 250	Ø 300	Ø 350	Ø 400	Ø 450	Ø 500	Ø 600
Da [mm]	Ø 150	Ø 170	Ø 183	Ø 200	Ø 220	Ø 250	Ø 270	Ø 320	Ø 370	Ø 420	Ø 470	Ø 520	Ø 570	Ø 670

**3U05RMF## - Regenhaube für Mündungsabschluss** RG: 3U

##-Kürzel	08	10	11	13	15	18	20	25	30	35	40	45	50	60
€/Stk.	76,1	76,1	76,1	82,2	90,4	98,8	107,-	117,-	132,-	195,-	213,-	244,-	269,-	305,-
E [mm]	176	190	199,1	211	225	246	260	295	330	365	400	435	470	540

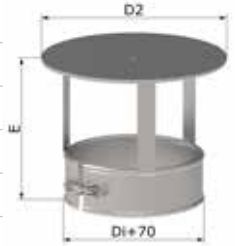

**3U05RHF## - Regenhaube für Mündungsabschluss inkl. Spannring und Funkenflug.** RG: 3U

##-Kürzel			11	13	15	18	20	25	30	35	40	45	50	60
€/Stk.			145,-	157,-	165,-	184,-	194,-	230,-	284,-	409,-	503,-	578,-	685,-	898,-
E [mm]			199,1	211	225	246	260	295	330	365	400	435	470	540



**3U05RHH## - Trekkende Kap mit Mündungsabschluss** RG: 3U

##-Kürzel	08	10	11	13	15	18	20	25						
€/Stk.	202,-	202,-	202,-	202,-	202,-	222,-	234,-	279,-						
E [mm]	90	110	120	145	165	200	220	275						
D2 [mm]	183	220	250	270	320	370	420	470						

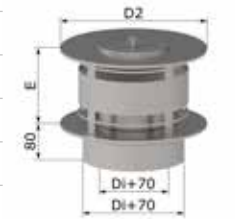

mindert Schwankungen durch Windeinflüsse und stabilisiert den Zug im Schornstein

**3U05RVH## - Ventushaube mit Mündungsabschluss** RG: 3U

##-Kürzel	08	10	11	13	15	18	20	25						
€/Stk.	178,-	178,-	178,-	178,-	178,-	200,-	211,-	261,-						
E [mm]	200	200	200	200	200	230	250	300						
D2 [mm]	230	250	263	280	300	330	370	450						



fördert den Schornsteinzug bei Fallwinden und mindert Strömungsgeräusche

**9900KKF## - Kugelkopf** RG: Z

##-Kürzel					15	20								
€/Stk.					375,-	422,-								



**9900KFL## - Flansch für Kugelkopf** RG: Z

##-Kürzel					15	20	30							
€/Stk.					33,5	42,-	82,3							

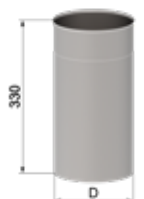



# SYSTEM III FU

Di [mm]	Ø 80	Ø 100	Ø 113	Ø 130	Ø 150	Ø 180	Ø 200	Ø 250	Ø 300	Ø 350	Ø 400	Ø 450	Ø 500	Ø 600
Da [mm]	Ø 150	Ø 170	Ø 183	Ø 200	Ø 220	Ø 250	Ø 270	Ø 320	Ø 370	Ø 420	Ø 470	Ø 520	Ø 570	Ø 670

**3U05DAE## - Dachdurchführung 0° Edelstahl** RG: 3U

##-Kürzel	08	10	11	13	15	18	20	25	30	35	40	45	50	60
€/Stk.	146,-	146,-	146,-	146,-	146,-	146,-	165,-	194,-	196,-	209,-	216,-	224,-	241,-	254,-
A [mm]	624	650	650	650	650	700	750	800	850	900	950	990	990	1150

Regenabweiser mit Hinterlüftung zur Abdeckung des Ringspalts erforderlich

**3U05DE1## - Dachdurchführung 5° - 25° Edelstahl** RG: 3U

##-Kürzel	08	10	11	13	15	18	20	25	30	35	40	45		
€/Stk.	199,-	199,-	199,-	213,-	216,-	238,-	267,-	293,-	318,-	341,-	361,-	410,-		
A [mm]	650	670	680	700	720	750	770	820	870	920	970	1020		
B [mm]	780	800	820	840	860	900	920	980	1030	1090	1150	1210		

Regenabweiser mit Hinterlüftung zur Abdeckung des Ringspalts erforderlich

**3U05DE2## - Dachdurchführung 20° - 35° Edelstahl** RG: 3U

##-Kürzel	08	10	11	13	15	18	20	25	30	35	40	45		
€/Stk.	217,-	217,-	217,-	228,-	239,-	271,-	325,-	325,-	361,-	390,-	409,-	450,-		
A [mm]	650	670	680	700	720	750	770	820	870	920	970	1020		
B [mm]	850	880	900	920	950	1000	1020	1100	1170	1240	1310	1380		

Regenabweiser mit Hinterlüftung zur Abdeckung des Ringspalts erforderlich

**3U05DE3## - Dachdurchführung 30° - 45° Edelstahl** RG: 3U

##-Kürzel	08	10	11	13	15	18	20	25	30	35	40	45		
€/Stk.	244,-	244,-	244,-	250,-	269,-	306,-	319,-	381,-	430,-	454,-	508,-	564,-		
A [mm]	620	640	660	670	690	720	740	790	840	890	940	990		
B [mm]	970	1010	1050	1080	1120	1180	1230	1330	1440	1550	1650	1760		

Regenabweiser mit Hinterlüftung zur Abdeckung des Ringspalts erforderlich

**3U05DE4## - Dachdurchführung 40° - 60° Edelstahl** RG: 3U

##-Kürzel	08	10	11	13	15	18	20	25	30	35	40	45		
€/Stk.	244,-	244,-	244,-	250,-	269,-	306,-	319,-	381,-	430,-	454,-	508,-	564,-		
A [mm]	620	640	660	670	690	720	740	790	840	890	940	990		
B [mm]	970	1010	1050	1080	1120	1180	1230	1330	1440	1550	1650	1750		

Regenabweiser mit Hinterlüftung zur Abdeckung des Ringspalts erforderlich

**3U05DR1## - Dachdurchführung 5° - 25° Edelstahl - Prägebahn ziegelrot (bleifrei)** RG: 3U

##-Kürzel	08	10	11	13	15	18	20	25						
€/Stk.	216,-	216,-	216,-	234,-	236,-	256,-	269,-	318,-						
A [mm]	880	880	880	880	880	1010	1010	1010						
B [mm]	750	750	750	750	750	750	750	750						

Regenabweiser mit Hinterlüftung zur Abdeckung des Ringspalts erforderlich

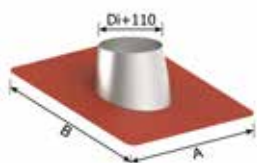
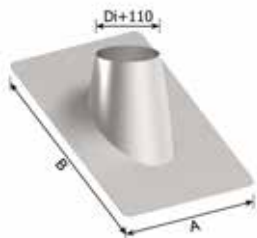
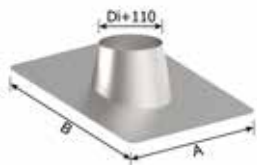
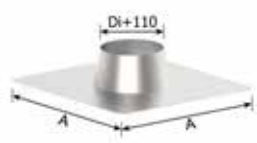



Di [mm]	Ø 80	Ø 100	Ø 113	Ø 130	Ø 150	Ø 180	Ø 200	Ø 250	Ø 300	Ø 350	Ø 400	Ø 450	Ø 500	Ø 600
Da [mm]	Ø 150	Ø 170	Ø 183	Ø 200	Ø 220	Ø 250	Ø 270	Ø 320	Ø 370	Ø 420	Ø 470	Ø 520	Ø 570	Ø 670
<b>3U05DR2## - Dachdurchführung 20° - 35° Edelstahl - Prägebahn ziegelrot (bleifrei)</b>														<b>RG: 3U</b>
##-Kürzel	08	10	11	13	15	18	20	25						
€/Stk.	<b>238,-</b>	<b>238,-</b>	<b>238,-</b>	<b>248,-</b>	<b>258,-</b>	<b>300,-</b>	<b>306,-</b>	<b>347,-</b>						
A [mm]	880	880	880	880	880	1010	1010	1010						
B [mm]	750	750	750	750	750	750	750	750						
Regenabweiser mit Hinterlüftung zur Abdeckung des Ringspalts erforderlich														
<b>3U05DR3## - Dachdurchführung 30° - 45° Edelstahl - Prägebahn ziegelrot (bleifrei)</b>														<b>RG: 3U</b>
##-Kürzel	08	10	11	13	15	18	20	25						
€/Stk.	<b>267,-</b>	<b>267,-</b>	<b>267,-</b>	<b>274,-</b>	<b>289,-</b>	<b>336,-</b>	<b>349,-</b>	<b>418,-</b>						
A [mm]	1010	1010	1010	1010	1200	1200	1200	1200						
B [mm]	750	750	750	750	750	750	750	750						
Regenabweiser mit Hinterlüftung zur Abdeckung des Ringspalts erforderlich														
<b>3U05DR4## - Dachdurchführung 40° - 60° Edelstahl - Prägebahn ziegelrot (bleifrei)</b>														<b>RG: 3U</b>
##-Kürzel	08	10	11	13	15	18	20	25						
€/Stk.	<b>267,-</b>	<b>267,-</b>	<b>267,-</b>	<b>274,-</b>	<b>289,-</b>	<b>336,-</b>	<b>349,-</b>	<b>418,-</b>						
A [mm]	1010	1010	1010	1010	1200	1200	1200	1200						
B [mm]	750	750	750	750	750	750	750	750						
Regenabweiser mit Hinterlüftung zur Abdeckung des Ringspalts erforderlich														
<b>3U05DS1## - Dachdurchführung 5° - 25° Edelstahl - Prägebahn anthrazit (bleifrei)</b>														<b>RG: 3U</b>
##-Kürzel	08	10	11	13	15	18	20	25						
€/Stk.	<b>216,-</b>	<b>216,-</b>	<b>216,-</b>	<b>234,-</b>	<b>236,-</b>	<b>256,-</b>	<b>269,-</b>	<b>318,-</b>						
A [mm]	880	880	880	880	880	1010	1010	1010						
B [mm]	750	750	750	750	750	750	750	750						
Regenabweiser mit Hinterlüftung zur Abdeckung des Ringspalts erforderlich														
<b>3U05DS2## - Dachdurchführung 20° - 35° Edelstahl - Prägebahn anthrazit (bleifrei)</b>														<b>RG: 3U</b>
##-Kürzel	08	10	11	13	15	18	20	25						
€/Stk.	<b>238,-</b>	<b>238,-</b>	<b>238,-</b>	<b>248,-</b>	<b>258,-</b>	<b>300,-</b>	<b>306,-</b>	<b>347,-</b>						
A [mm]	880	880	880	880	880	1010	1010	1010						
B [mm]	750	750	750	750	750	750	750	750						
Regenabweiser mit Hinterlüftung zur Abdeckung des Ringspalts erforderlich														
<b>3U05DS3## - Dachdurchführung 30° - 45° Edelstahl - Prägebahn anthrazit (bleifrei)</b>														<b>RG: 3U</b>
##-Kürzel	08	10	11	13	15	18	20	25						
€/Stk.	<b>267,-</b>	<b>267,-</b>	<b>267,-</b>	<b>274,-</b>	<b>289,-</b>	<b>336,-</b>	<b>349,-</b>	<b>418,-</b>						
A [mm]	1010	1010	1010	1010	1200	1200	1200	1200						
B [mm]	750	750	750	750	750	750	750	750						
Regenabweiser mit Hinterlüftung zur Abdeckung des Ringspalts erforderlich														
<b>3U05DS4## - Dachdurchführung 40° - 60° Edelstahl - Prägebahn anthrazit (bleifrei)</b>														<b>RG: 3U</b>
##-Kürzel	08	10	11	13	15	18	20	25						
€/Stk.	<b>267,-</b>	<b>267,-</b>	<b>267,-</b>	<b>274,-</b>	<b>289,-</b>	<b>336,-</b>	<b>349,-</b>	<b>418,-</b>						
A [mm]	1010	1010	1010	1010	1200	1200	1200	1200						
B [mm]	750	750	750	750	750	750	750	750						
Regenabweiser mit Hinterlüftung zur Abdeckung des Ringspalts erforderlich														

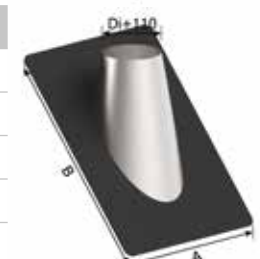
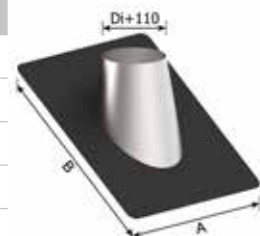
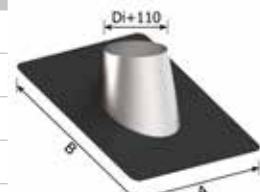
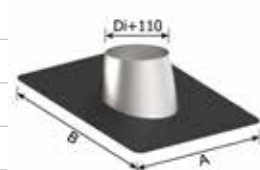
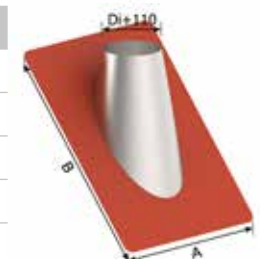
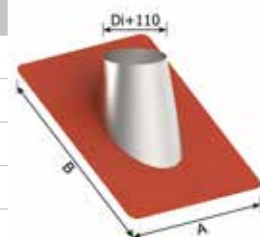
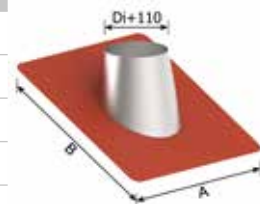



Di [mm]	Ø 80	Ø 100	Ø 113	Ø 130	Ø 150	Ø 180	Ø 200	Ø 250	Ø 300	Ø 350	Ø 400	Ø 450	Ø 500	Ø 600
Da [mm]	Ø 150	Ø 170	Ø 183	Ø 200	Ø 220	Ø 250	Ø 270	Ø 320	Ø 370	Ø 420	Ø 470	Ø 520	Ø 570	Ø 670

### Dachdurchführung für Trapezblech

RG: 3U

99DAT1 - Dachdurchführung für Trapezblech - Außendurchmesser 6 - 146 mm	€/Stk.	218,-
99DAT2 - Dachdurchführung für Trapezblech - Außendurchmesser 102 - 210 mm	€/Stk.	313,-
99DAT3 - Dachdurchführung für Trapezblech - Außendurchmesser 140 - 292 mm	€/Stk.	379,-
99DAT4 - Dachdurchführung für Trapezblech - Außendurchmesser 241 - 520 mm	€/Stk.	417,-
99DAT5 - Dachdurchführung für Trapezblech - Außendurchmesser 305 - 724 mm	€/Stk.	1553,-

Außendurchmesser richtet sich nach Di+170mm bezogen auf das Hülsrohr

### 3U05DHS## - Hülsrohr z. Hinterlüftung DAT

RG: 3U

##-Kürzel	08	10	11	13	15	18	20	25	30	35	40	45	50
€/Stk.	143,-	149,-	151,-	157,-	161,-	171,-	179,-	205,-	224,-	249,-	270,-	296,-	320,-
D2 [mm]	250	270	283	300	320	350	370	420	470	570	620	670	720

Regenabweiser mit Hinterlüftung zur Abdeckung des Ringspalts erforderlich

### 3U05R00##H - Regenabweiser mit Hinterlüftung

RG: 3U

##-Kürzel	08	10	11	13	15	18	20	25	30	35	40	45	50	60
€/Stk.	38,7	40,-	41,-	41,2	44,5	45,7	47,1	55,2	65,9	85,4	90,3	95,5	108,-	124,-

### 3U05SS1## - Spannring

RG: 3U

##-Kürzel	08	10	11	13	15	18	20	25	30	35	40	45	50	60
€/Stk.	17,-	17,-	17,-	17,2	19,5	20,3	22,5	23,8	24,8	27,-	27,-	31,8	36,5	42,5

### 3U05W40## - Wandbefestigung, variabel 50-125mm

RG: 3U

##-Kürzel		13	15	18	20
€/Stk.		62,8	65,3	69,-	72,6
A [mm]		252	274	307	329
B [mm]		287	309	342	364

### 3U05A20## - Verlängerung Wandbefestigung W40 125-260mm

RG: 3U

##-Kürzel		13	15	18	20
€/Stk.		19,9	20,4	21,7	22,2



Spannverschluss Di+82







Di [mm]	Ø 80	Ø 100	Ø 113	Ø 130	Ø 150	Ø 180	Ø 200	Ø 250	Ø 300	Ø 350	Ø 400	Ø 450	Ø 500	Ø 600
Da [mm]	Ø 150	Ø 170	Ø 183	Ø 200	Ø 220	Ø 250	Ø 270	Ø 320	Ø 370	Ø 420	Ø 470	Ø 520	Ø 570	Ø 670

**3U05A21## - Verlängerung Wandbefestigung W40 125-410mm** RG: 3U

##-Kürzel				13	15	18	20							
€/Stk.				35,-	36,1	39,2	41,7							



**3U05W20## - Wandbefestigung Wandabstand 50mm** RG: 3U

##-Kürzel	08	10	11	13	15	18	20	25	30	35	40	45	50	60
€/Stk.	65,4	65,4	65,4	65,4	71,4	76,7	76,9	92,-	95,7	110,-	110,-	143,-	154,-	171,-
A [mm]	118	135	148	163	180	206	224	267	310	353	397	440	484	570
B [mm]	174	191	204	219	236	262	280	323	366	409	453	496	540	626
C [mm]										170	170	170	170	170



**3U05A11## - Abstandhalter für Wandbefestigung 50-170mm** RG: 3U

##-Kürzel	08	10	11	13	15	18	20	25	30	35	40	45	50	60
€/Stk.	99,9	99,9	99,9	105,-	105,-	115,-	115,-	136,-	150,-	173,-	217,-	258,-	300,-	361,-
A [mm]	118	135	148	163	180	206	224	267	310	353	397	440	484	570
B [mm]	174	191	204	219	236	262	280	323	366	409	453	496	540	626
C [mm]										170	170	170	170	170

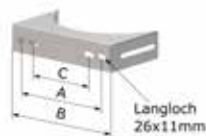

**3U05A12## - Abstandhalter für Wandbefestigung 170-290mm** RG: 3U

##-Kürzel	08	10	11	13	15	18	20	25	30	35	40	45	50	60
€/Stk.	136,-	136,-	136,-	151,-	151,-	160,-	169,-	215,-	215,-	236,-	267,-	307,-	365,-	413,-
A [mm]	118	135	148	163	180	206	224	267	310	353	397	440	484	570
B [mm]	174	191	204	219	236	262	280	323	366	409	453	496	540	626
C [mm]										170	170	170	170	170

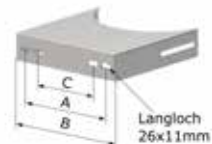

**3U05A13## - Abstandhalter für Wandbefestigung 290-410mm** RG: 3U

##-Kürzel	08	10	11	13	15	18	20	25	30	35	40	45	50	60
€/Stk.	195,-	195,-	195,-	195,-	196,-	214,-	222,-	243,-	280,-	318,-	416,-	497,-	596,-	678,-
A [mm]	118	135	148	163	180	206	224	267	310	353	397	440	484	570
B [mm]	174	191	204	219	236	262	280	323	366	409	453	496	540	626
C [mm]										170	170	170	170	170

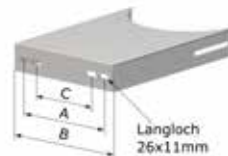

**Montagewinkel für Wandbefestigung W20** RG: 3U

99A11 - Montagewinkel für Wandbefestigung Wandabstand: 50 - 170 mm	€/Stk.	64,1
99A12 - Montagewinkel für Wandbefestigung Wandabstand: 170 - 290 mm	€/Stk.	75,7
99A13 - Montagewinkel für Wandbefestigung Wandabstand: 290 - 410 mm	€/Stk.	87,3



max. Schornsteinhöhe 10m



Di [mm]	Ø 80	Ø 100	Ø 113	Ø 130	Ø 150	Ø 180	Ø 200	Ø 250	Ø 300	Ø 350	Ø 400	Ø 450	Ø 500	Ø 600
Da [mm]	Ø 150	Ø 170	Ø 183	Ø 200	Ø 220	Ø 250	Ø 270	Ø 320	Ø 370	Ø 420	Ø 470	Ø 520	Ø 570	Ø 670

### 3U05DK0## - Dachkonsole

RG: 3U

##-Kürzel	08	10	11	13	15	18	20	25	30	35	40	45	50	60
€/Stk.	79,4	79,4	79,4	80,1	81,3	88,7	91,6	94,8	101,-	107,-	119,-	122,-	125,-	132,-

drehbare Flügel für Decken- und Dachkonstruktionen

### Abdeckblende 2tlg.

RG: 3U

##-Kürzel	08	10	11	13	15	18	20	25	30	35	40	45	50	60
3U05R02## - 0-30°	49,2	49,2	49,3	51,8	54,8	61,7	61,7	71,8	83,3	94,1	94,1	122,-	137,-	184,-
3U05R03## - 20-45°	47,1	49,-	51,6	54,3	55,-	61,8	66,3	79,8	83,7	94,1	110,-	137,-	139,-	195,-
3U05R04## - 40-60°	49,2	51,7	54,4	62,4	63,2	72,1	72,1	90,3	110,-	115,-	137,-	193,-	195,-	248,-

### Abdeckblende 2tlg. mit Hinterlüftung

RG: 3U

##-Kürzel	08	10	11	13	15	18	20	25	30	35	40	45	50	60
3U05R02##H - 0-30°	50,-	50,-	52,-	54,5	58,2	65,-	65,2	85,-	95,8	103,-	110,-	131,-	146,-	194,-
3U05R03##H - 20-45°	54,8	54,8	54,8	55,-	58,3	69,8	69,8	84,8	102,-	108,-	116,-	149,-	154,-	203,-
3U05R04##H - 40-60°	62,8	62,8	62,8	66,9	68,2	77,1	84,6	93,-	113,-	124,-	149,-	195,-	236,-	259,-

### 3U05R01## - Mauerblende

RG: 3U

##-Kürzel	08	10	11	13	15	18	20	25	30	35	40	45	50	60
€/Stk.	27,1	27,1	27,1	30,2	31,4	34,8	34,9	45,7	45,8	65,4	95,5	104,-	108,-	143,-

### 3U05RH1## - Mauerblende mit Hinterlüftung

RG: 3U

##-Kürzel	08	10	11	13	15	18	20	25	30	35	40	45	50	60
€/Stk.	29,4	29,4	29,4	32,3	34,1	36,4	40,8	49,-	62,8	85,4	113,-	125,-	131,-	163,-

### 3U05R05## - Mauerblende schmal

RG: 3U

##-Kürzel	08	10	11	13	15	18	20	25	30	35	40	45	50	60
€/Stk.	18,1	19,5	19,5	21,5	23,6	24,9	27,9	31,2	43,5	50,-	63,2	54,3	65,7	108,-



Di [mm]	Ø 80	Ø 100	Ø 113	Ø 130	Ø 150	Ø 180	Ø 200	Ø 250	Ø 300	Ø 350	Ø 400	Ø 450	Ø 500	Ø 600
Da [mm]	Ø 150	Ø 170	Ø 183	Ø 200	Ø 220	Ø 250	Ø 270	Ø 320	Ø 370	Ø 420	Ø 470	Ø 520	Ø 570	Ø 670

**Wanddurchführung** RG: 3U

##-Kürzel			11	13	15	18	20							
A x A [mm]			400x400	400x400	400x400	450x450	450x450							
3U05WA1## - T: 120mm* €/Stk.			<b>100,-</b>	<b>112,-</b>	<b>116,-</b>	<b>135,-</b>	<b>137,-</b>							
3U05WA2## - T: 240mm* €/Stk.			<b>135,-</b>	<b>159,-</b>	<b>161,-</b>	<b>194,-</b>	<b>196,-</b>							*kürzbar
3U05WA3## - T: 360mm* €/Stk.			<b>173,-</b>	<b>204,-</b>	<b>211,-</b>	<b>254,-</b>	<b>259,-</b>							Je nach Einbaubedingung
3U05WA4## - T: 440mm* €/Stk.			<b>240,-</b>	<b>269,-</b>	<b>278,-</b>	<b>327,-</b>	<b>348,-</b>							ist eine Strahlungsplatte notwendig



**99STP - Strahlungsplatte aus Calciumsilikat 600x600mm** RG: 3U

														€/Stk. <b>68,6</b>

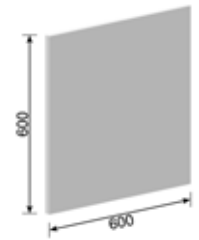

Stärke t=20mm

**3U05RWA## - Abdeckblende Wanddurchführung 2tlg.** RG: 3U

##-Kürzel			11	13	15	18	20							
€/Stk.			<b>59,7</b>	<b>59,7</b>	<b>59,7</b>	<b>69,6</b>	<b>69,6</b>							
A [mm]			500	500	500	550	550							

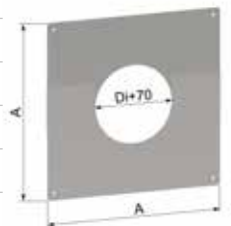

**3U05S00## - Seilabspannring** RG: 3U

##-Kürzel	08	10	11	13	15	18	20	25	30	35	40	45	50	60
€/Stk.	<b>48,4</b>	<b>48,4</b>	<b>48,4</b>	<b>49,4</b>	<b>50,5</b>	<b>59,9</b>	<b>59,9</b>	<b>69,6</b>	<b>72,9</b>	<b>72,9</b>	<b>80,6</b>	<b>82,3</b>	<b>82,3</b>	<b>88,1</b>
Anzahl Laschen	3	3	3	3	3	3	3	3	3	3	4	4	4	4



**3U05SSV## - Stutzen für Schornsteinkopfverlängerung** RG: 3U

##-Kürzel			11	13	15	18	20	25	30	35	40	45	50	60
€/Stk.			<b>168,-</b>	<b>184,-</b>	<b>184,-</b>	<b>191,-</b>	<b>203,-</b>	<b>230,-</b>	<b>243,-</b>	<b>288,-</b>	<b>337,-</b>	<b>413,-</b>	<b>587,-</b>	<b>587,-</b>
A [mm]			340	360	380	410	430	480	530	580	630	680	730	830

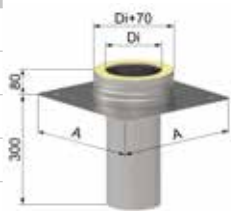

Stutzen mit Hinterlüftung auf Anfrage erhältlich

**3U05SSZ## - Stutzen für Schornsteinkopfverlängerung (Sondermaß)** RG: 3U

##-Kürzel			11	13	15	18	20	25	30					
€/Stk.			<b>209,-</b>	<b>230,-</b>	<b>230,-</b>	<b>240,-</b>	<b>249,-</b>	<b>274,-</b>	<b>304,-</b>					
A [mm]			340	360	380	410	430	480	530					

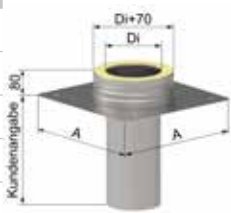

Stutzenmaß = Kundenangabe



Di [mm]	Ø 80	Ø 100	Ø 113	Ø 130	Ø 150	Ø 180	Ø 200	Ø 250	Ø 300	Ø 350	Ø 400	Ø 450	Ø 500	Ø 600
Da [mm]	Ø 150	Ø 170	Ø 183	Ø 200	Ø 220	Ø 250	Ø 270	Ø 320	Ø 370	Ø 420	Ø 470	Ø 520	Ø 570	Ø 670

**3U05KK1## - Bogen 15° kurz** **RG: 3U**

##-Kürzel	08	10	11	13	15	18	20	25	30	35	40	45	50	60
€/Stk.	106,-	106,-	106,-	117,-	125,-	135,-	150,-	184,-	222,-	284,-	311,-	350,-	380,-	417,-
A [mm]	60	62	64	66	69	73	76	82	89	95	102	108	115	128
B [mm]	120	122	124	126	129	133	136	142	149	155	162	168	175	188
C [mm]	216	219	220	222	225	229	232	238	244	251	257	264	270	283

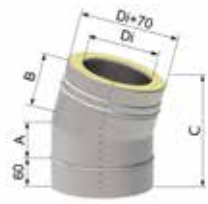

**3U05KK2## - Bogen 30° kurz** **RG: 3U**

##-Kürzel	08	10	11	13	15	18	20	25	30	35	40	45	50	60
€/Stk.	109,-	109,-	109,-	122,-	134,-	149,-	161,-	200,-	243,-	300,-	325,-	373,-	405,-	464,-
A [mm]	80	86	89	94	99	107	112	126	139	153	166	179	193	220
B [mm]	140	146	149	154	159	167	172	186	199	213	226	239	253	280
C [mm]	224	229	232	237	242	249	254	267	279	292	304	317	329	354



**3U05KK3## - Bogen 45° kurz** **RG: 3U**

##-Kürzel	08	10	11	13	15	18	20	25	30	35	40	45	50	60
€/Stk.	116,-	116,-	116,-	134,-	137,-	165,-	171,-	213,-	257,-	313,-	345,-	381,-	435,-	464,-
A [mm]	102	110	116	123	131	144	152	173	193	214	235	255	276	318
B [mm]	162	170	176	183	191	204	212	233	253	274	295	315	336	378
C [mm]	224	231	235	241	248	259	266	284	302	319	337	355	372	408

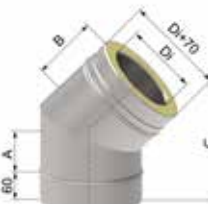

**3U05KK0## - Bogen 87°** **RG: 3U**

##-Kürzel	08	10	11	13	15	18	20	25	30	35	40	45	50	60
€/Stk.	211,-	259,-	259,-	259,-	282,-	332,-	341,-	332,-	454,-	610,-	768,-	963,-	1144,-	1475,-
A [mm]	139	148	154	162	172	186	196	219	243	267	291	314	338	385
B [mm]	199	208	214	222	232	246	256	279	303	327	351	374	398	445

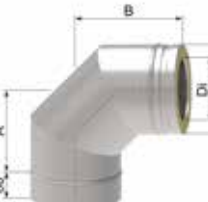

**3U05LMS## - Längenelement mit Wasserfalle und Ablauf (senkrecht)** **RG: 3U**

##-Kürzel	08	10	11	13	15	18	20	25	30	35	40	45		
€/Stk.	209,-	209,-	209,-	230,-	252,-	314,-	350,-	386,-	435,-	440,-	487,-	541,-		



nur senkrechter Einbau | innenliegend 10mm umlaufende Rinne



Di [mm]	Ø 80	Ø 100	Ø 113	Ø 130	Ø 150	Ø 180	Ø 200	Ø 250	Ø 300	Ø 350	Ø 400	Ø 450	Ø 500	Ø 600
Da [mm]	Ø 150	Ø 170	Ø 183	Ø 200	Ø 220	Ø 250	Ø 270	Ø 320	Ø 370	Ø 420	Ø 470	Ø 520	Ø 570	Ø 670

**3U05800## - Längenausgleich 260-380mm** RG: 3U

##-Kürzel	08	10	11	13	15	18	20	25	30	35	40	45	50	60
€/Stk.	171,-	171,-	171,-	180,-	180,-	189,-	204,-	243,-	270,-	301,-	323,-	386,-	418,-	483,-



**3U05900## - Längenausgleich 380-620mm** RG: 3U

##-Kürzel	08	10	11	13	15	18	20	25	30	35	40	45	50	60
€/Stk.	211,-	203,-	203,-	211,-	223,-	241,-	254,-	314,-	351,-	391,-	428,-	517,-	562,-	652,-

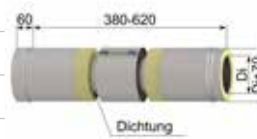

**Teleskoparm für Wandbefestigung W20** RG: Z

99501 - Teleskoparm für Wandbefestigung (Paar) - Typ 1, H: 500 - 900 mm	€/Stk.	233,-
99502 - Teleskoparm für Wandbefestigung (Paar) - Typ 2, H: 800 - 1500 mm	€/Stk.	280,-
99503 - Teleskoparm für Wandbefestigung (Paar) - Typ 3, H: 1400 - 2700 mm	€/Stk.	410,-



**99513 - Dachhaken (Paar)** RG: Z

€/Stk.	82,9
--------	------

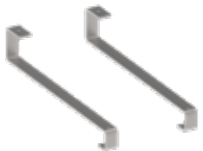

**99351 - Stopfen 1/2"** RG: Z

€/Stk.	13,1
--------	------



**99150 - Seil, Stärke 4 mm (lfdm.)** RG: Z

€/lfdm.	9,4
---------	-----







# SYSTEM III FU

Di [mm]	Ø 80	Ø 100	Ø 113	Ø 130	Ø 150	Ø 180	Ø 200	Ø 250	Ø 300	Ø 350	Ø 400	Ø 450	Ø 500	Ø 600
Da [mm]	Ø 150	Ø 170	Ø 183	Ø 200	Ø 220	Ø 250	Ø 270	Ø 320	Ø 370	Ø 420	Ø 470	Ø 520	Ø 570	Ø 670

**99180 - Seilspanner** RG: Z



€/Stk. 9,7

**99160 - Kauschen - Stärke: 4 mm** RG: Z



€/Stk. 2,1

**99170 - Klemme - Stärke: 4-5 mm** RG: Z



€/Stk. 7,4

**99019 - Schablone für Bohrungen für Konsolenbleche** RG: 3U



Auf Anfrage

unterschiedliche Ausführungen | auf Anfrage bestellbar

**9900KA0## - Kragarm verzinkt (Quadratrohr 100x100mm)** RG: Z

##-Kürzel	08	10	11	13	15	18	20	25	30	35	40	45	50	60
€/Stk.	548,-	548,-	548,-	548,-	548,-	548,-	548,-	683,-	683,-	683,-	683,-	683,-	683,-	683,-
a	190	190	190	190	190	190	190	220	220	220	220	220	220	220
b	90	90	90	90	90	90	90	120	120	120	120	120	120	120
A	250	250	250	250	250	250	250	300	300	300	300	300	300	300
B	150	150	150	150	150	150	150	200	200	200	200	200	200	200

Sperrgut: es entstehen zusätzliche Frachtkosten

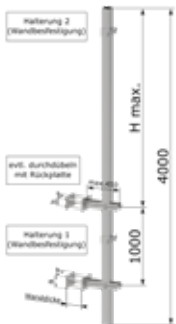



SYSTEMBESCHREIBUNG

# System III G

Das System III G ist ein doppelwandiges, wärmedämmtes Edelstahlabgassystem für Feuerstätten im Unterdruckbetrieb in trockener Betriebsweise. Das Design bietet die perfekte Verbindung von leistungsfähiger Technik und moderner Architektur ohne Ecken und Kanten. Gefertigt wird das System in den Durchmessern 130 mm bis 200 mm.

**Oberflächen Außenmantel**

matt 2B	Standard	3G05-
glänzend 2R	ohne Aufpreis	3GE5-
gebürstet	20% Aufpreis	Auf Anfrage
RAL-Lackierung**	40% Aufpreis	Auf Anfrage
Kupfer	50% Aufpreis	Auf Anfrage

Material Innenrohr

1.4539	85% Aufschlag	Auf Anfrage
--------	---------------	-------------

\*\* Mindest-Bestellwert 100,- € netto

Brennstoff	Festbrennstoffe	✓
	Pellets	✓
	Gas	✓
	Heizöl EL	✓
Werkstoff innen & Betriebsweise	<b>1.4404</b>	rußbrandbeständig oder feuchteunempfindlich
	<b>1.4539</b> (auf Anfrage)	rußbrandbeständig und feuchteunempfindlich
Werkstoff außen	<b>1.4301</b> matt	(weitere Oberflächen auf Anfrage)
Druckklasse	N1	✓ -40 Pa
	P1	⊖
	H1	⊖
Max. Abgastemperatur	600°C	
Wärmedämmung	35 mm	
Wandstärke	0,5 mm	
Verbindung	Steckverbindung Muffe/Sicke mit Klemmverschluss	
Spannring	⊖ nicht erforderlich	
Für waagerechten Einbau (VB-Leitung) geeignet	✓	





Durchmesser innen (Di) [mm]	Ø 130	Ø 150	Ø 180	Ø 200
Durchmesser außen (Da) [mm]	Ø 200	Ø 220	Ø 250	Ø 270
<b>3G05P3S## - Paket - Standard 3,3m</b> <span style="float:right">RG: 3U</span>				
##-Kürzel	13	15	18	20
€/Stk.	1595,-	1595,-	1773,-	2017,-
Höhe [mm]	3680	3680	3730	3730
Gewicht [kg]	39	47	52	57



### PAKET - STANDARD 3,3M

Profil-Konsole 500mm, kürzbar	99K02	1 Stk.
Fundamentverankerung mit Ablauf für Profil-Konsole	3G05VGC##	1 Stk.
Prüf- & Reinigungs-Element mit geb. Tür (trocken)	3G05P30##	1 Stk.
F-Anschluss 90°	3G05F90##	1 Stk.
Übergangsstück kürzbar flach mit Wandfutter L: 500mm	3G05UFK##	1 Stk.
Mauerblende	3U05R01##	1 Stk.
Längenelement 1000mm	3G05100##	3 Stk.
Mündungsabschluss flach	3G05MFL##	1 Stk.
Wandbefestigung, variabel 50-125mm	3U05W40##	1 Stk.

Durchmesser innen (Di) [mm]	Ø 130	Ø 150	Ø 180	Ø 200
Durchmesser außen (Da) [mm]	Ø 200	Ø 220	Ø 250	Ø 270

### 3G05SFA## - Stützfuß mit seidl. Ablauf

RG: 3U



##-Kürzel	13	15	18	20
€/Stk.	241,-	241,-	269,-	309,-

in der Höhe kürzbar

### 3G05SF1## - Stützfuß mit Reinigungstür und Flansch innen

RG: 3U

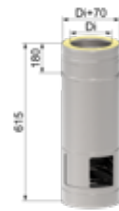

##-Kürzel	13	15	18	20
€/Stk.	307,-	307,-	337,-	386,-

in der Höhe kürzbar

### 3G05V0C## - Fundamentverankerung mit Kondensattopf für Profil-Konsole

RG: 3U

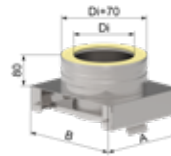

##-Kürzel	13	15	18	20
€/Stk.	136,-	136,-	163,-	189,-
A [mm]	240	260	290	310
B [mm]	260	280	310	330

### 3G05VGC## - Fundamentverankerung mit Ablauf für Profil-Konsole

RG: 3U

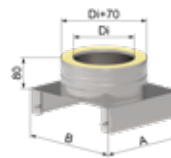

##-Kürzel	13	15	18	20
€/Stk.	118,-	118,-	129,-	151,-
A [mm]	240	260	290	310
B [mm]	260	280	310	330

### 3G05Z0C## - Zwischenstütze für Profil-Konsole

RG: 3U

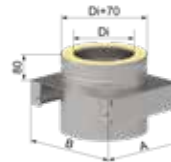

##-Kürzel	13	15	18	20
€/Stk.	131,-	131,-	154,-	202,-
A [mm]	240	260	290	310
B [mm]	260	280	310	330

### 3G05P30## - Prüf- & Reinigungs-Element mit geb. Tür (trocken)

RG: 3U



##-Kürzel	13	15	18	20
€/Stk.	283,-	283,-	311,-	396,-



Langlöcher 21x11mm

### 99K02 - Profil-Konsole 500mm, kürzbar

RG: 3U

€/Stk. 144,-

### 99K00 - Profil-Konsole 750mm, kürzbar

RG: 3U

€/Stk. 173,-



Langlöcher 21x11mm



Durchmesser innen (Di) [mm]	Ø 130	Ø 150	Ø 180	Ø 200
Durchmesser außen (Da) [mm]	Ø 200	Ø 220	Ø 250	Ø 270

**3G05P40## - Prüf- & Reinigungs-Element mit geb. Tür (feucht) RG: 3U**



##-Kürzel	13	15	18	20
€/Stk.	293,-	293,-	320,-	408,-

Durchmesser innen (Di) [mm]	Ø 130	Ø 150	Ø 180	Ø 200
Durchmesser außen (Da) [mm]	Ø 200	Ø 220	Ø 250	Ø 270

**3G05033## - Längenelement 330mm RG: 3U**



##-Kürzel	13	15	18	20
€/Stk.	99,8	99,8	112,-	129,-

**3G05PF3## - Kombiniertes Grundelement P + F 90° mit Ablauf - Stutzen höhenversetzt RG: 3U**



##-Kürzel	13	15	18	20
€/Stk.	554,-	554,-	634,-	729,-
A [mm]	350	370	380	390
B [mm]	161	172	187	197
C [mm]	180	190	210	220

**3G05025## - Längenelement 250mm RG: 3U**



##-Kürzel	13	15	18	20
€/Stk.	87,3	87,3	95,7	111,-

**3G05F90## - F-Anschluss 90° RG: 3U**



##-Kürzel	13	15	18	20
€/Stk.	217,-	217,-	260,-	325,-
A [mm]	140	140	165	165
B [mm]	161	172	187	197
C [mm]	200	200	225	225

**3G05UFF## - Übergangsstück mit Wandfutter RG: 3U**

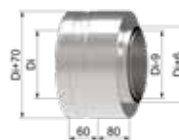

##-Kürzel	13	15	18	20
€/Stk.	109,-	109,-	137,-	159,-

mit Rohrhülsenadapter kombinierbar

**3G05F45## - F-Anschluss 45° RG: 3U**

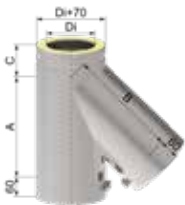

##-Kürzel	13	15	18	20
€/Stk.	315,-	315,-	431,-	518,-
A [mm]	290	300	441	451
B [mm]	303	327	363	387
C [mm]	150	140	249	239

**3G05UFE## - Übergangsstück kürzbar mit Wandfutter und einw. Stutzen L: 500mm RG: 3U**



##-Kürzel	13	15	18	20
€/Stk.	155,-	155,-	188,-	215,-

mit Rohrhülsenadapter kombinierbar

**3G05100## - Längenelement 1000mm RG: 3U**



##-Kürzel	13	15	18	20
€/Stk.	217,-	217,-	247,-	284,-

**3G05UFK## - Übergangsstück kürzbar flach mit Wandfutter L: 500mm RG: 3U**



##-Kürzel	13	15	18	20
€/Stk.	155,-	155,-	188,-	215,-

mit Rohrhülsenadapter kombinierbar

**3G05050## - Längenelement 500mm RG: 3U**



##-Kürzel	13	15	18	20
€/Stk.	127,-	127,-	141,-	160,-

**3G05UFR#### - Übergangsstück mit reduziertem Wandfutter RG: 3U**



####-Kürzel	1312	1513	1813	2018
€/Stk.	118,-	118,-	157,-	179,-
Dx [mm]	120	130	130	180



Durchmesser innen (Di) [mm]	Ø 130	Ø 150	Ø 180	Ø 200
Durchmesser außen (Da) [mm]	Ø 200	Ø 220	Ø 250	Ø 270

**3G05UEF## - Übergangsstück für Feuerungsanschluss** RG: 3U

##-Kürzel	13	15	18	20
€/Stk.	90,1	90,1	116,-	134,-



Durchmesser innen (Di) [mm]	Ø 130	Ø 150	Ø 180	Ø 200
Durchmesser außen (Da) [mm]	Ø 200	Ø 220	Ø 250	Ø 270

**3G05RVH## - Ventushaube mit Mündungsabschluss** RG: 3U

##-Kürzel	13	15	18	20
€/Stk.	178,-	178,-	200,-	230,-
E [mm]	200	200	230	250
D2 [mm]	280	300	330	370



fördert den Schornsteinzug bei Fallwinden und mindert Strömungsgeräusche

**3G05MK1## - Endstück doppelwandig VB-Leitung auf einwandig Muffe** RG: 3U

##-Kürzel	13	15	18	20
€/Stk.	97,1	97,1	126,-	146,-



**3G05RHH## - Trekkende Kap mit Mündungsabschluss** RG: 3U

##-Kürzel	13	15	18	20
€/Stk.	202,-	202,-	222,-	254,-
E [mm]	145	165	200	220
D2 [mm]	270	320	370	420



mindert Schwankungen durch Windeinflüsse und stabilisiert den Zug im Schornstein

**1U05RHA##XX - Rohrhülsenadapter inkl. Wandfutter** RG: 1U

##-Kürzel	130	150	180	200
€/Stk.	103,-	103,-	103,-	103,-
XX-Kürzel	Dx reduziert - Kundenangabe			



**9900KKF## - Kugelkopf** RG: Z

##-Kürzel	15	20
€/Stk.	375,-	422,-



**3G05MFL## - Mündungsabschluss flach** RG: 3U

##-Kürzel	13	15	18	20
€/Stk.	72,3	72,3	80,7	92,7

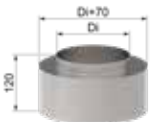

**9900KFL## - Flansch für Kugelkopf** RG: Z

##-Kürzel	15	20
€/Stk.	33,5	42,-



**3G05RH0## - Mündungsabschluss mit Regenhaube** RG: 3U

##-Kürzel	13	15	18	20
€/Stk.	127,-	127,-	136,-	158,-

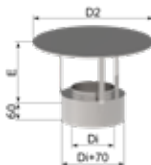

**3U05R00##H - Regenabweiser mit Hinterlüftung** RG: 3U

##-Kürzel	13	15	18	20
€/Stk.	41,2	44,5	45,7	47,1



**3G05RHF## - Mündungsabschluss mit Regenhaube und Funkenflugg.** RG: 3U

##-Kürzel	13	15	18	20
€/Stk.	165,-	165,-	184,-	212,-



**Dachdurchführung für Trapezblech** RG: 3U

99DAT1 - Außen ø 6 - 146 mm	€/Stk.	218,-
99DAT2 - Außen ø 102 - 210 mm	€/Stk.	313,-
99DAT3 - Außen ø 140 - 292 mm	€/Stk.	379,-
99DAT4 - Außen ø 241 - 520 mm	€/Stk.	417,-



Außendurchmesser richtet sich nach Di+170mm bezogen auf das Hülsrohr





Durchmesser innen (Di) [mm]	Ø 130	Ø 150	Ø 180	Ø 200
Durchmesser außen (Da) [mm]	Ø 200	Ø 220	Ø 250	Ø 270

**3U05DHS## - Hülsrohr z. Hinterlüftung DAT** **RG: 3U**



##-Kürzel	13	15	18	20
€/Stk.	157,-	161,-	171,-	179,-
D2 [mm]	300	320	350	370

Regenabweiser mit Hinterlüftung zur Abdeckung des Ringspalts erforderlich

**3U05DAE## - Dachdurchführung 0° Edelstahl** **RG: 3U**

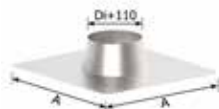

##-Kürzel	13	15	18	20
€/Stk.	146,-	146,-	146,-	165,-
A [mm]	650	650	700	750

Regenabweiser mit Hinterlüftung zur Abdeckung des Ringspalts erforderlich

**3U05DE1## - Dachdurchführung 5° - 25° Edelstahl** **RG: 3U**

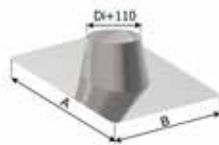

##-Kürzel	13	15	18	20
€/Stk.	213,-	216,-	238,-	267,-
A [mm]	700	720	750	770
B [mm]	840	860	900	920

Prägebahn ziegelrot (bleifrei)

Regenabweiser erforderlich

**3U05DE2## - Dachdurchführung 20° - 35° Edelstahl** **RG: 3U**

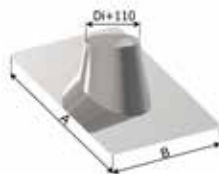

##-Kürzel	13	15	18	20
€/Stk.	228,-	239,-	271,-	325,-
A [mm]	700	720	750	770
B [mm]	920	950	1000	1020

Prägebahn ziegelrot (bleifrei)

Regenabweiser erforderlich

**3U05DE3## - Dachdurchführung 30° - 45° Edelstahl** **RG: 3U**

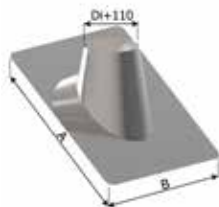

##-Kürzel	13	15	18	20
€/Stk.	250,-	269,-	306,-	319,-
A [mm]	670	690	720	740
B [mm]	1080	1120	1180	1230

Prägebahn ziegelrot (bleifrei)

Regenabweiser erforderlich

**3U05DE4## - Dachdurchführung 40° - 60° Edelstahl** **RG: 3U**

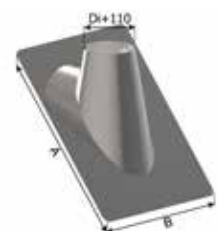

##-Kürzel	13	15	18	20
€/Stk.	250,-	269,-	306,-	319,-
A [mm]	670	690	720	740
B [mm]	1080	1120	1180	1230

Prägebahn ziegelrot (bleifrei)

Regenabweiser erforderlich

Durchmesser innen (Di) [mm]	Ø 130	Ø 150	Ø 180	Ø 200
Durchmesser außen (Da) [mm]	Ø 200	Ø 220	Ø 250	Ø 270

**3U05DR1## - Dachdurchführung 5° - 25° Edelstahl** **RG: 3U**

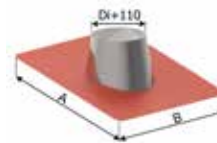

##-Kürzel	13	15	18	20
€/Stk.	234,-	236,-	256,-	269,-
A [mm]	880	880	1010	1010
B [mm]	750	750	750	750

Prägebahn ziegelrot (bleifrei)

Regenabweiser erforderlich

**3U05DR2## - Dachdurchführung 20° - 35° Edelstahl** **RG: 3U**

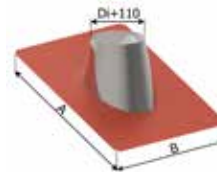

##-Kürzel	13	15	18	20
€/Stk.	248,-	258,-	300,-	306,-
A [mm]	880	880	1010	1010
B [mm]	750	750	750	750

Prägebahn ziegelrot (bleifrei)

Regenabweiser erforderlich

**3U05DR3## - Dachdurchführung 30° - 45° Edelstahl** **RG: 3U**



##-Kürzel	13	15	18	20
€/Stk.	274,-	289,-	336,-	349,-
A [mm]	1010	1200	1200	1200
B [mm]	750	750	750	750

Prägebahn ziegelrot (bleifrei)

Regenabweiser erforderlich

**3U05DR4## - Dachdurchführung 40° - 60° Edelstahl** **RG: 3U**

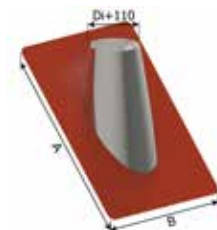

##-Kürzel	13	15	18	20
€/Stk.	274,-	289,-	336,-	349,-
A [mm]	1010	1200	1200	1200
B [mm]	750	750	750	750

Prägebahn ziegelrot (bleifrei)

Regenabweiser erforderlich

**3U05DS1## - Dachdurchführung 5° - 25° Edelstahl** **RG: 3U**

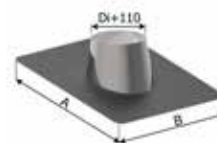

##-Kürzel	13	15	18	20
€/Stk.	234,-	236,-	256,-	269,-
A [mm]	880	880	1010	1010
B [mm]	750	750	750	750

Prägebahn ziegelrot (bleifrei)

Regenabweiser erforderlich

**3U05DS2## - Dachdurchführung 20° - 35° Edelstahl** **RG: 3U**

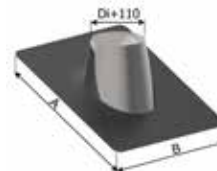

##-Kürzel	13	15	18	20
€/Stk.	248,-	258,-	300,-	306,-
A [mm]	880	880	1010	1010
B [mm]	750	750	750	750

Prägebahn ziegelrot (bleifrei)

Regenabweiser erforderlich



Durchmesser innen (Di) [mm]      Ø 130    Ø 150    Ø 180    Ø 200

Durchmesser außen (Da) [mm]      Ø 200    Ø 220    Ø 250    Ø 270

**3U05DS3## - Dachdurchführung 30° - 45° Edelstahl      RG: 3U**

##-Kürzel	13	15	18	20
€/Stk.	274,-	289,-	336,-	349,-
A [mm]	1010	1200	1200	1200
B [mm]	750	750	750	750

Prägebahn ziegelrot (bleifrei)  
Regenabweiser erforderlich

**3U05DS4## - Dachdurchführung 40° - 60° Edelstahl      RG: 3U**

##-Kürzel	13	15	18	20
€/Stk.	274,-	289,-	336,-	349,-
A [mm]	1010	1200	1200	1200
B [mm]	750	750	750	750

Prägebahn ziegelrot (bleifrei)  
Regenabweiser erforderlich

**3U05W40## - Wandbefestigung, variabel 50-125mm      RG: 3U**

##-Kürzel	13	15	18	20
€/Stk.	62,8	65,3	69,-	72,6
A [mm]	252	274	307	329
B [mm]	287	309	342	364

**3U05A20## - Verlängerung Wandbefestigung W40 125-260mm      RG: 3U**

##-Kürzel	13	15	18	20
€/Stk.	19,9	20,4	21,7	22,2

**3U05A21## - Verlängerung Wandbefestigung W40 125-410mm      RG: 3U**

##-Kürzel	13	15	18	20
€/Stk.	35,-	36,1	39,2	41,7

**3U05W20## - Wandbefestigung Wandabstand 50mm      RG: 3U**

##-Kürzel	13	15	18	20
€/Stk.	65,4	71,4	76,7	76,9
A [mm]	163	180	206	224
B [mm]	219	236	262	280

Durchmesser innen (Di) [mm]      Ø 130    Ø 150    Ø 180    Ø 200

Durchmesser außen (Da) [mm]      Ø 200    Ø 220    Ø 250    Ø 270

**3U05A11## - Abstandhalter für Wandbefestigung 50-170mm      RG: 3U**

##-Kürzel	13	15	18	20
€/Stk.	105,-	105,-	115,-	115,-
A [mm]	163	180	206	224
B [mm]	219	236	262	280

**3U05A12## - Abstandhalter für Wandbefestigung 170-290mm      RG: 3U**

##-Kürzel	13	15	18	20
€/Stk.	151,-	151,-	160,-	169,-
A [mm]	163	180	206	224
B [mm]	219	236	262	280

**3U05A13## - Abstandhalter für Wandbefestigung 290-410mm      RG: 3U**

##-Kürzel	13	15	18	20
€/Stk.	195,-	196,-	214,-	222,-
A [mm]	163	180	206	224
B [mm]	219	236	262	280

**Montagewinkel für Wandbefestigung W20      RG: 3U**

99A11 - Wandabstand: 50 - 170 mm	€/Stk.	64,1
99A12 - Wandabstand: 170 - 290 mm	€/Stk.	75,7
99A13 - Wandabstand: 290 - 410 mm	€/Stk.	87,3

max. Schornsteinhöhe 10m

**3U05DK0## - Dachkonsole      RG: 3U**

##-Kürzel	13	15	18	20
€/Stk.	80,1	81,3	88,7	91,6

**3G05MSB## - Mantelschelle / Blende      RG: 3U**

##-Kürzel	13	15	18	20
€/Stk.	27,1	27,1	28,5	32,9



Durchmesser innen (Di) [mm]	Ø 130	Ø 150	Ø 180	Ø 200
Durchmesser außen (Da) [mm]	Ø 200	Ø 220	Ø 250	Ø 270

**3G05SKL## - Statisches Klemmband** RG: 3U



##-Kürzel	13	15	18	20
€/Stk.	109,-	109,-	114,-	132,-

**Abdeckblende 2tlg.** RG: 3U



##-Kürzel	13	15	18	20
3U05R02## - 0-30°	51,8	54,8	61,7	61,7
3U05R03## - 20-45°	54,3	55,-	61,8	66,3
3U05R04## - 40-60°	62,4	63,2	72,1	72,1

**Abdeckblende 2tlg. mit Hinterlüftung** RG: 3U

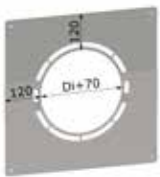

##-Kürzel	13	15	18	20
3U05R02##H - 0-30°	54,5	58,2	65,-	65,2
3U05R03##H - 20-45°	55,-	58,3	69,8	69,8
3U05R04##H - 40-60°	66,9	68,2	77,1	84,6

**3U05R01## - Mauerblende** RG: 3U



##-Kürzel	13	15	18	20
€/Stk.	30,2	31,4	34,8	34,9

**3U05RH1## - Mauerblende mit Hinterlüftung** RG: 3U



##-Kürzel	13	15	18	20
€/Stk.	32,3	34,1	36,4	40,8

**3U05R05## - Mauerblende schmal** RG: 3U

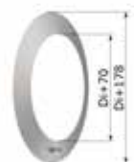

##-Kürzel	13	15	18	20
€/Stk.	21,5	23,6	24,9	27,9

Durchmesser innen (Di) [mm]	Ø 130	Ø 150	Ø 180	Ø 200
Durchmesser außen (Da) [mm]	Ø 200	Ø 220	Ø 250	Ø 270

**Wanddurchführung** \*kürzbar RG: 3U



##-Kürzel	13	15	18	20
A x A [mm]	400x400	400x400	450x450	450x450
3U05WA1## - T: 120mm *	112,-	116,-	135,-	137,-
3U05WA2## - T: 240mm *	159,-	161,-	194,-	196,-
3U05WA3## - T: 360mm *	204,-	211,-	254,-	259,-
3U05WA4## - T: 440mm *	269,-	278,-	327,-	348,-

**99STP - Strahlungsplatte aus Calciumsilikat 600x600mm** RG: 3U

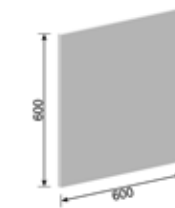

€/Stk.	68,6
Stärke t=20mm	
Je nach Einbaubedingung der Wanddurchführung ist eine Strahlungsplatte erforderlich	

**3U05RWA## - Abdeckblende Wanddurchführung 2tlg.** RG: 3U

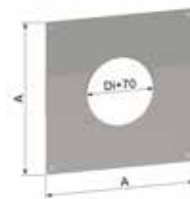

##-Kürzel	13	15	18	20
€/Stk.	59,7	59,7	69,6	69,6
A [mm]	500	500	550	550

**3U05S00## - Seilabspannring** RG: 3U



##-Kürzel	13	15	18	20
€/Stk.	49,4	50,5	59,9	59,9

**3G05SSV## - Stutzen für Schornsteinkopfverlängerung** RG: 3U

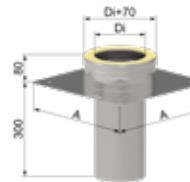

##-Kürzel	13	15	18	20
€/Stk.	212,-	212,-	221,-	252,-
A [mm]	360	380	410	430

**3G05SSZ## - Stutzen für Schornsteinkopfverlängerung (Sondermaß)** RG: 3U

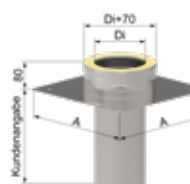

##-Kürzel	13	15	18	20
€/Stk.	259,-	259,-	271,-	312,-
A [mm]	360	380	410	430

Stutzenmaß = Kundenangabe



Durchmesser innen (Di) [mm]      Ø 130    Ø 150    Ø 180    Ø 200

Durchmesser außen (Da) [mm]      Ø 200    Ø 220    Ø 250    Ø 270

**3G05KK1## - Bogen 15° | Verschluss innen**      **RG: 3U**

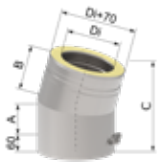

##-Kürzel	13	15	18	20
€/Stk.	146,-	146,-	158,-	181,-
A [mm]	66	69	73	76
B [mm]	126	129	133	136
C [mm]	222	225	229	232

**3G05KB1## - Bogen 15° | Verschluss außen**      **RG: 3U**

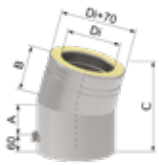

##-Kürzel	13	15	18	20
€/Stk.	146,-	146,-	158,-	181,-
A [mm]	51	52	54	55
B [mm]	111	112	114	115
C [mm]	218	220	224	227

**3G05KK2## - Bogen 30° | Verschluss innen**      **RG: 3U**



##-Kürzel	13	15	18	20
€/Stk.	157,-	157,-	170,-	195,-
A [mm]	94	99	107	112
B [mm]	154	159	167	172
C [mm]	237	242	249	254

**3G05KB2## - Bogen 30° | Verschluss außen**      **RG: 3U**



##-Kürzel	13	15	18	20
€/Stk.	157,-	157,-	170,-	195,-
A [mm]	64	67	71	74
B [mm]	124	127	131	134
C [mm]	232	237	244	249

**3G05KK3## - Bogen 45° | Verschluss innen**      **RG: 3U**

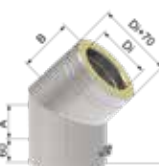

##-Kürzel	13	15	18	20
€/Stk.	165,-	165,-	187,-	214,-
A [mm]	123	131	144	152
B [mm]	183	191	204	212
C [mm]	241	248	259	266

**3G05KB3## - Bogen 45° | Verschluss außen**      **RG: 3U**

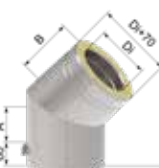

##-Kürzel	13	15	18	20
€/Stk.	165,-	165,-	187,-	214,-
A [mm]	79	83	89	93
B [mm]	139	143	149	153
C [mm]	237	244	255	262

Durchmesser innen (Di) [mm]      Ø 130    Ø 150    Ø 180    Ø 200

Durchmesser außen (Da) [mm]      Ø 200    Ø 220    Ø 250    Ø 270

**3G05KK7## - Bogen 90°**      **RG: 3U**



##-Kürzel	13	15	18	20
€/Stk.	302,-	302,-	351,-	406,-
A [mm]	168	178	193	203
B [mm]	228	238	253	263

**3G05KN6## - Bogen 90° mit Reinigung**      **RG: 3U**



##-Kürzel	13	15	18	20
€/Stk.	342,-	342,-	368,-	420,-
A [mm]	225	235	250	260
B [mm]	285	295	310	320
d [mm]	130	150	150	150

**3G05KN6##R - Bogen 90° mit seitr. Reinigung rechts**      **RG: 3U**



##-Kürzel	13	15	18	20
€/Stk.	342,-	342,-	368,-	420,-
A [mm]	225	235	250	260
B [mm]	285	295	310	320
d [mm]	130	150	150	150

**3G05KN6##L - Bogen 90° mit seitr. Reinigung links**      **RG: 3U**



##-Kürzel	13	15	18	20
€/Stk.	342,-	342,-	368,-	420,-
A [mm]	225	235	250	260
B [mm]	285	295	310	320
d [mm]	130	150	150	150

**3G05800## - Längenausgleich 260-380mm**      **RG: 3U**

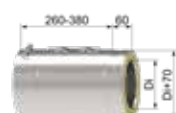

##-Kürzel	13	15	18	20
€/Stk.	202,-	202,-	211,-	256,-

**3G05900## - Längenausgleich 380-620 mm**      **RG: 3U**



##-Kürzel	13	15	18	20
€/Stk.	243,-	243,-	261,-	303,-

A large grid of small dots for taking notes, consisting of approximately 30 columns and 40 rows.

A large grid of small dots for taking notes, covering most of the page.



A large grid of small dots for taking notes, covering most of the page.

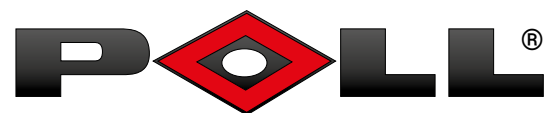

Schornsteinsysteme aus Edelstahl



Bernhard Poll  
Schornsteintechnik GmbH  
Industriestraße 16  
D-26892 Dörpen/Ems  
Telefon +49 (0) 4963 / 9188-0  
Telefax +49 (0) 4963 / 9188-88  
info@poll-schornsteine.de

[www.poll-schornsteine.de](http://www.poll-schornsteine.de)